

ETICS with stone wool slabs



THERMO ISOVER

European Technical Assessment
ETA-23/0314

External thermal insulation with stone wool

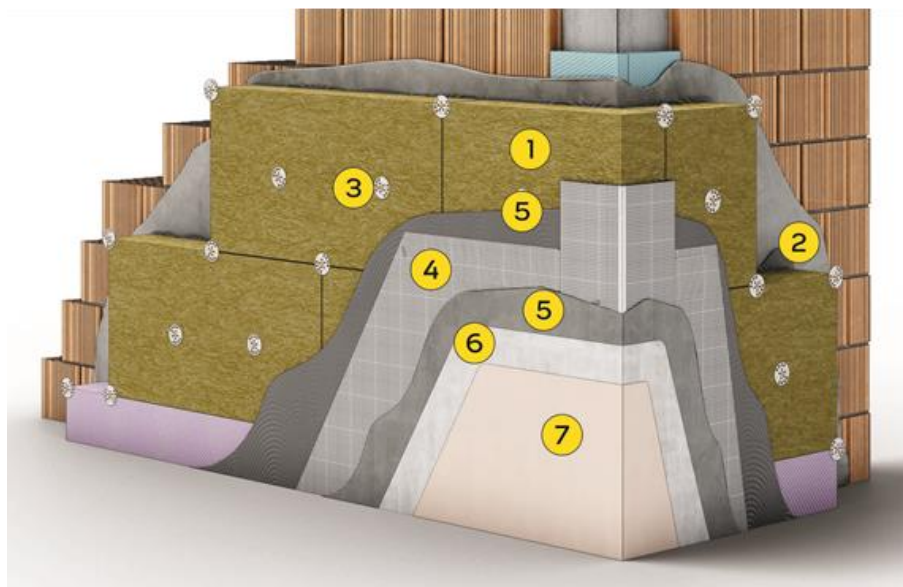

Reaction to fire
Class A2-s1, d0

Water absorption
- after 1 h :
 < 0,1 kg/m²
- after 24 h :
 < 0,5 kg/m²

Resistant to
hygrothermal cycles

Freeze-thaw resistant

Impact resistance :
Category III

Water vapour permeability of the rendering system
 $s_d \leq 0,48$ m

Medium bond strength between the adhesive and the substrate:
 ≥ 870 kPa

Thermal resistance
 $R_{\text{masonry+ETICS}} = 4,945$
(m²·K)/W (and according to the specifications table)

Thermal insulation product

- ① **ISOVER FASSADE** or **ISOVER PROFI FASSADE**
Stone wool slabs, produced in the factory – according to SR EN 13162 and to the specifications of the present sheet

Adhesive for fixing the thermal insulation slabs

- ② **ISOVER PROFI FASSADE FIX**
Adhesive for bonding stone wool slabs, in powder form, cement-based, with a high content of synthetic resins and reinforcing fibers - medium layer thickness 10 mm

Anchors

- ③ **ISOVER PROFI FASSADE ANCHOR**
Anchors with polypropylene plate and metal nail with large expansion area, for fixing stone wool slabs
or
ISOVER PROFI FASSADE ANCHOR PB
Anchors with polypropylene plate and metal nail, having low thermal bridge, for fixing stone wool slabs

Base coat

- ⑤ **ISOVER PROFI FASSADE FIX**
Base coat for reinforcing stone wool slabs, in powder form, cement-based, with a high content of synthetic resins and reinforcing fibers - medium layer thickness 4 mm

Reinforcement

- ④ **ISOVER PROFI FASSADE MESH**
Glass fibre mesh, resistant to the alkaline environment, with a minimum density of 160 g/m²

Key coat

- ⑥ **ISOVER PROFI FASSADE PRIME**
Product based on silicone dispersions, with the addition of additives and quartz sand. For priming surfaces before applying decorative renders

Finishing coat
Decorative render

- ⑦ **ISOVER PROFI FASSADE DECOR**
Ready-to-use decorative render, in paste form, based on silicone dispersions and special additives - average layer thickness 1.5...2 mm (depending on granulation)
type R955 - fine grain / type R855 - medium grain / type R655 - rolling grain

Reaction to fire of ETICS

Class A2-s1, d0
(Stone wool ISOVER FASSADE, ISOVER PROFI FASSADE: Class A1)

Water absorption of the base coat and the rendering system

Water absorption of the reinforced base coat			
ETICS configuration requirements:		After 1 h [kg/m ²]	After 24 h [kg/m ²]
ISOVER PROFI FASSADE FIX		0.03	0.36

Water absorption of the complete rendering system				
ETICS configuration requirements:			After 1 h [kg/m ²]	After 24 h [kg/m ²]
Base coat	Key coat	Finishing coat		
ISOVER PROFI FASSADE FIX	ISOVER PROFI FASSADE PRIME	ISOVER PROFI FASSADE DECOR	0.08	0.09

Water absorption of the insulation product

Water absorption of the insulation product		
ETICS configuration requirements:		After 24 h [kg/m ²]
ISOVER FASSADE		1.0
ISOVER PROFI FASSADE		1.0

Water-tightness of the ETICS: hygrothermal behaviour

Water-tightness of the ETICS: hygrothermal behaviour
ETICS resistant to hygrothermal cycles.*

*The resistance to hygrothermal cycles allows ETICS to be evaluated in terms of avoiding water penetration and the appearance of important defects such as cracks > 0.2 mm, exfoliation, breaks in the plastering or insulating material, cracks in the joint area etc.

Water-tightness: freeze thaw performance

Water-tightness: freeze thaw performance
The ETICS is freeze-thaw resistant , because the water absorption of both, reinforced base coat and the rendering system, are less than 0,5 kg/m ² after 24 hours.

Impact resistance

Impact resistance (products tested after hygrothermal cycles on the rig)					
ETICS configuration requirements:			Cracks	Max. impact diameter [mm]	Impact resistance category
Base coat	Reinforcement and key coat	Finishing coat			
ISOVER PROFI FASSADE FIX	ISOVER PROFI FASSADE MESH and ISOVER PROFI FASSADE PRIME	ISOVER PROFI FASSADE DECOR	Yes - 3 J Yes - 10 J	35 - 3 J 60 - 10 J	III

Water vapour permeability of the rendering system

Water vapour permeability of the rendering system (equivalent air thickness, s _d)			
ETICS configuration requirements:			Equivalent air thickness s _d [m]
Base coat	Key coat	Finishing coat	
ISOVER PROFI FASSADE FIX	ISOVER PROFI FASSADE PRIME	ISOVER PROFI FASSADE DECOR	0.48

Water vapor permeability of the thermal insulation product

Water vapor permeability of the thermal insulation product (water-vapor resistance factor)	
ETICS configuration requirements:	Water vapor resistance factor μ [-]
ISOVER FASSADE	1
ISOVER PROFI FASSADE	1

Bond strength between the base coat and the thermal insulation product

Bond strength between the base coat and the thermal insulation product (mortar or paste)					
ETICS configuration requirements:		Conditioning before the test	Rupture type	Bond strength [kPa]	
Insulation product	Base coat			Min.	Mean
ISOVER FASSADE	ISOVER PROFI FASSADE FIX	Initial state (dry condition)	In the insulation product	12	14
ISOVER FASSADE	ISOVER PROFI FASSADE FIX	After hygrothermal cycles	In the insulation product	6	7
ISOVER PROFI FASSADE	ISOVER PROFI FASSADE FIX	Initial state (dry condition)	In the insulation product	12	13
ISOVER PROFI FASSADE	ISOVER PROFI FASSADE FIX	After hygrothermal cycles	In the insulation product	8	9

Bond strength between the adhesive and the substrate

Bond strength between the adhesive and the substrate					
ETICS configuration requirements:		Conditioning before the test	Rupture type	Bond strength [kPa]	
Substrate	Adhesive (and tested thickness)			Min.	Mean
Concrete	ISOVER PROFI FASSADE FIX (4 - 6 mm)	Initial state (dry condition)	In the adhesive	896	1080
Concrete	ISOVER PROFI FASSADE FIX (4 - 6 mm)	2 days immersion and 2 hours drying	In the adhesive	766	870
Concrete	ISOVER PROFI FASSADE FIX (4 - 6 mm)	2 days immersion and min. 7 days drying	In the adhesive	1458	1820

Bond strength between the adhesive and the thermal insulation product

Bond strength between the adhesive and the thermal insulation product					
ETICS configuration requirements:		Conditioning before the test	Rupture type	Bond strength [kPa]	
Insulation product	Adhesive (and tested thickness)			Min.	Mean
ISOVER FASSADE	ISOVER PROFI FASSADE FIX (4 - 6 mm)	Initial state (dry condition)	In the insulation product	10	11
ISOVER FASSADE	ISOVER PROFI FASSADE FIX (4 - 6 mm)	2 days immersion and 2 hours drying	In the insulation product	9	9
ISOVER FASSADE	ISOVER PROFI FASSADE FIX (4 - 6 mm)	2 days immersion and min. 7 days drying	In the insulation product	11	12
ISOVER PROFI FASSADE	ISOVER PROFI FASSADE FIX (4 - 6 mm)	Initial state (dry condition)	In the insulation product	11	12
ISOVER PROFI FASSADE	ISOVER PROFI FASSADE FIX (4 - 6 mm)	2 days immersion and 2 hours drying	In the insulation product	11	13
ISOVER PROFI FASSADE	ISOVER PROFI FASSADE FIX (4 - 6 mm)	2 days immersion and min. 7 days drying	In the insulation product	12	13

Wind load resistance of ETICS

Wind load resistance of ETICS					
Assessed by means of: pull-through tests of fixings					
ETICS configuration requirements:		Tested position	Test conditions	Failure load per fixing [kN]	
Insulation product	Fixing			Individual	Mean
ISOVER FASSADE (MW) Thickness: ≥ 50 mm Tensile strength in dry condition: ≥ 14 kPa	Surface assembly of: ISOVER PROFI FASSADE ANCHOR or ISOVER PROFI FASSADE ANCHOR PB	R_{panel} 	Dry condition 23 °C and 50 % relative air humidity	0.415 0.400 0.318 0.328 0.358	0.364

Wind load resistance of ETICS					
Assessed by means of: pull-through tests of fixings					
ETICS configuration requirements:		Tested position	Test conditions	Failure load per fixing [kN]	
Insulation product	Fixing			Individual	Mean
ISOVER FASSADE (MW) Thickness: ≥ 50 mm Tensile strength in dry condition: ≥ 14 kPa	Surface assembly of: ISOVER PROFI FASSADE ANCHOR or ISOVER PROFI FASSADE ANCHOR PB	R_{joint} 	Dry condition 23 °C and 50 % relative air humidity	0.267 0.288 0.294 0.305 0.350	0.301

Wind load resistance of ETICS					
Assessed by means of: pull-through tests of fixings					
ETICS configuration requirements:		Tested position	Test conditions	Failure load per fixing [kN]	
Insulation product	Fixing			Individual	Mean
ISOVER PROFI FASSADE (MW) Thickness: ≥ 50 mm Tensile strength in dry condition: ≥ 18.5 kPa	Surface assembly of: ISOVER PROFI FASSADE ANCHOR or ISOVER PROFI FASSADE ANCHOR PB	R_{panel} 	Dry condition 23 °C and 50 % relative air humidity	0.423 0.405 0.389 0.452 0.386	0.411

Wind load resistance of ETICS					
Assessed by means of: pull-through tests of fixings					
ETICS configuration requirements:		Tested position	Test conditions	Failure load per fixing [kN]	
Insulation product	Fixing			Individual	Mean
ISOVER PROFI FASSADE (MW) Thickness: ≥ 50 mm Tensile strength in dry condition: ≥ 18.5 kPa	Surface assembly of: ISOVER PROFI FASSADE ANCHOR or ISOVER PROFI FASSADE ANCHOR PB	R_{joint} 	Dry condition 23 °C and 50 % relative air humidity	0.338 0.335 0.342 0.325 0.329	0.334

Wind load resistance of ETICS

Wind load resistance of ETICS					
Assessed by means of: pull-through tests of fixings					
ETICS configuration requirements:		Tested position	Test conditions	Failure load per fixing [kN]	
Insulation product	Fixing			Individual	Mean
ISOVER FASSADE (MW) Thickness: ≥ 50 mm Tensile strength in dry condition: ≥ 14 kPa Tensile strength in wet condition: ≥ 6.0 kPa	Surface assembly of: ISOVER PROFI FASSADE ANCHOR or ISOVER PROFI FASSADE ANCHOR PB	R_{panel} 	Wet condition 70 °C and 95 % relative air humidity	0.202 0.233 0.237 0.211 0.187	0.214

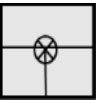
Wind load resistance of ETICS					
Assessed by means of: pull-through tests of fixings					
ETICS configuration requirements:		Tested position	Test conditions	Failure load per fixing [kN]	
Insulation product	Fixing			Individual	Mean
ISOVER FASSADE (MW) Thickness: ≥ 50 mm Tensile strength in dry condition: ≥ 14 kPa Tensile strength in wet condition: ≥ 6.0 kPa	Surface assembly of: ISOVER PROFI FASSADE ANCHOR or ISOVER PROFI FASSADE ANCHOR PB	R_{joint} 	Wet condition 70 °C and 95 % relative air humidity	0.185 0.172 0.184 0.158 0.154	0.171

Wind load resistance of ETICS					
Assessed by means of: pull-through tests of fixings					
ETICS configuration requirements:		Tested position	Test conditions	Failure load per fixing [kN]	
Insulation product	Fixing			Individual	Mean
ISOVER PROFI FASSADE (MW) Thickness: ≥ 50 mm Tensile strength in dry condition: $\geq 18,5$ kPa Tensile strength in wet condition: ≥ 9.0 kPa	Surface assembly of: ISOVER PROFI FASSADE ANCHOR or ISOVER PROFI FASSADE ANCHOR PB	R_{panel} 	Wet condition 70 °C and 95 % relative air humidity	0.255 0.266 0.224 0.267 0.217	0.246

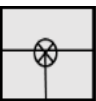
Wind load resistance of ETICS					
Assessed by means of: pull-through tests of fixings					
ETICS configuration requirements:		Tested position	Test conditions	Failure load per fixing [kN]	
Insulation product	Fixing			Individual	Mean
ISOVER PROFI FASSADE (MW) Thickness: ≥ 50 mm Tensile strength in dry condition: $\geq 18,5$ kPa Tensile strength in wet condition: ≥ 9.0 kPa	Surface assembly of: ISOVER PROFI FASSADE ANCHOR or ISOVER PROFI FASSADE ANCHOR PB	R_{joint} 	Wet condition 70 °C and 95 % relative air humidity	0.238 0.240 0.233 0.267 0.230	0.242

Tensile strength

Tensile test perpendicular to the faces of the thermal insulation product (in dry condition)			
ETICS configuration requirements:	Tested thickness [mm]	Tensile strength [kPa]	
		Min.	Med.
ISOVER FASSADE	Assessed by means of DoP	7.5	N/A
ISOVER FASSADE	50 mm	9.8	14
ISOVER PROFI FASSADE	Assessed by means of DoP	10	N/A
ISOVER PROFI FASSADE	50 mm	16.1	18.5

Tensile test perpendicular to the faces of the thermal insulation product (in wet condition)				
ETICS configuration requirements:	Tensile strength			
	70 °C and 95 % RH for 7 days + 23 °C and 50 % RH until constant mass		70 °C and 95 % RH for 28 days + 23 °C and 50 % RH until constant mass	
	Min. [kPa]	Mean [kPa]	Min. [kPa]	Mean [kPa]
ISOVER FASSADE	5	6	7	8
ISOVER PROFI FASSADE	8	9	8	10

Bond strength after ageing of the finishing coat tested in the rig

Bond strength after ageing of the finishing coat tested in the rig						
ETICS configuration requirements:				Rupture type	Bond strength [kPa]	
Insulation product	Base coat	Key coat	Finishing coat		Individual	Mean
ISOVER FASSADE	ISOVER PROFI FASSADE FIX	ISOVER PROFI FASSADE PRIME	ISOVER PROFI FASSADE DECOR	In the insulation product	9	7
				In the insulation product	8	
				In the insulation product	6	
				In the insulation product	7	
				In the insulation product	7	

Bond strength after ageing of the finishing coat tested in the rig						
ETICS configuration requirements:				Rupture type	Bond strength [kPa]	
Insulation product	Base coat	Key coat	Finishing coat		Individual	Mean
ISOVER PROFI FASSADE	ISOVER PROFI FASSADE FIX	ISOVER PROFI FASSADE PRIME	ISOVER PROFI FASSADE DECOR	In the insulation product	12	9
				In the insulation product	8	
				In the insulation product	8	
				In the insulation product	9	
				In the insulation product	9	

Tensile strength of the glass fibre mesh

Tensile strength of the glass fibre mesh				
ETICS configuration requirements:	As-delivered state			
	Tensile strength [N/mm]		Elongation [%]	
	Warp	Weft	Warp	Weft
ISOVER PROFI FASSADE MESH	33	57	4.0	4.6

Tensile strength of the glass fibre mesh				
ETICS configuration requirements:	After alkali ageing			
	Tensile strength [N/mm]		Elongation [%]	
	Warp	Weft	Warp	Weft
ISOVER PROFI FASSADE MESH	22	33	2.9	2.7

Thermal resistance and thermal transmittance of ETICS

Thermal resistance and thermal transmittance of ETICS (R_{ETICS})	
Thermal resistance	[(m ² ·K)/W]
R_{render}	0.02
R_{ETICS}	≥ 1.00
In order to meet criteria of EAD 040083-00-0404, R_{ETICS} - min. 1,0 (m ² ·K)/W	

Type of substrate	Stone wool type - thickness	Calculated Thermal resistance R' (m ² ·K/W)	Calculated Thermal transmittance U' (W/m ² ·K)
Brick with vertical holes 250 mm	ISOVER FASSADE ⁽¹⁾ 100 mm ⁽³⁾	3,784	0,264
	ISOVER FASSADE ⁽¹⁾ 150 mm ⁽⁴⁾	5,049	0,198
	ISOVER PROFI FASSADE ⁽²⁾ 100 mm ⁽³⁾	3,711	0,269
	ISOVER PROFI FASSADE ⁽²⁾ 150 mm ⁽⁴⁾	4,945	0,202

Note:

- thermal resistance calculations were performed for new constructions (dry state);
- the effect of thermal bridges (dowels etc.) on the total value of the thermal resistance was taken into account (according to the indications in EAD 040083-00-0404);
- the total thermal resistance value was calculated for the entire assembly made of solid support, the interior plaster (25 mm thick) and the ETICS system presented in this technical sheet.

⁽¹⁾ stone wool in the composition of the ETICS solution, thermal conductivity $\lambda_{10dry} = 0,035$ W/mk

⁽²⁾ stone wool in the composition of the ETICS solution, thermal conductivity $\lambda_{10dry} = 0,036$ W/mk

⁽³⁾ fulfills the thermal resistance condition for non-residential buildings NZEB accd. to Mc 001-2022

⁽⁴⁾ fulfills the thermal resistance condition for residential buildings NZEB accd. to Mc 001-2022

The current calculation is purely indicative. In order to establish the thermal efficiency of the building, the evaluation is done by the authorized factors of the project.

Main assembly operations (1/3)

Main execution operations	Description
Preparing the support layer	<ul style="list-style-type: none"> External thermal insulation works are carried out on concrete walls, brickwork, hollow brickwork (ceramic blocks) or autoclaved aerated concrete (AAC), on surfaces plastered with mortar based on hydraulic binders or directly on the brickwork. The support layer must be dry, load-bearing, stable, clean, free of non-stick substances (grease spots, bitumen etc.), free of dust and not have any unevenness greater than 1 cm. Concrete substrates must be older than 28 days and must be free of residues of separating formwork oil. In the case of old supports, all cracks must be repaired. The flatness of the wall surface will be checked with the help of the straightedge and the leveling stick. In case of flatness deviations less than 1 cm, a thicker layer of adhesive mortar will be applied to the stone wool slabs.
Mounting the socle profile	<ul style="list-style-type: none"> Draw with chalk rope the level at which the socle profile will be mounted, at a height of at least 30 cm above the ground. Installation is started from the outer or inner corner of the building. Fixing is done using screws with dowels, at a distance of 30-50 cm, leaving a gap of 2-3 mm between the profiles. For continuous jointing of the profiles, plastic connectors are used, which also provide the distance required for the expansion joint. In case of an uneven substrate, the flatness of the profiles can be adjusted using plastic spacers, which are mounted between the metal profile and the wall. The socle profile mounted in the area of the corners that delimit the building, is cut out in one piece, avoiding the joining of two profiles.
Bonding the stone wool slabs	<ul style="list-style-type: none"> Prepare the ISOVER PROFI FASSADE FIX adhesive, by mixing using an electric mixer, adding it to clean water, approx. 5.2-5.8 liters per 25 kg dry mortar, leave to rest approx. 5 minutes, re-mix, after which it can be used. The product must be used within the next 90 minutes. The surface of ISOVER PROFI FASSADE stone wool slabs will be cleaned of dust or other impurities, materials that could influence the adhesion. The adhesive is applied with a notched trowel in a continuous strip, with a width of 60 - 100 mm, on the entire perimeter of the stone wool slab and at several points (2-3) in the central area, having a diameter of 100-150 mm, so that, when mounting, the adhesive covers at least 40% of the surface. The adhesive, after it is applied on the contour and at a few points, is pressed with a notched trowel, to penetrate as well as possible between the fibers of the slab. In case of flat, even surfaces, the adhesive will be applied on the entire surface of the stone wool slab, using a 10-20 mm notched trowel. To increase adhesion, a thin layer of adhesive mortar will first be applied on the entire surface of the slab, smoothing with the right edge of the trowel. The laying of stone wool slabs is done starting on the socle profile, without joints, spaces between them and continuing upwards, on the wall of the building. The slabs are mounted interlaced (masonry type), including in the area of the corners of the facade, with a minimum gap of 15 cm between the previous and the next row, without adhesive in the joint areas. Their positioning will be adjusted, immediately after bonding, by pressing or tapping lightly. The verticality and flatness of the surface should be checked with the help of a straightener throughout the installing process of the slabs. At the corners of the facade, stone wool slabs must be mounted in interlaced system, the joints between the tiles must be clean and free of adhesive. In the corner areas of the openings (windows or doors), stone wool slabs should be mounted cut out in the shape of an "L", in such a way that the slab is at no point narrower than 15 - 20 cm. The joints between the slabs should not coincide with the edges of windows and doors. If a gap larger than 10 mm remains between two adjacent slabs, then it will be filled with a strip of mineral wool. Narrow spaces (approx. 4 mm) will be filled with polyurethane foam, with a low degree of expansion.
Mounting the anchors	<ul style="list-style-type: none"> After the curing of the adhesive, approx. 1-3 days after bonding the slabs, they are also fixed mechanically with the help of anchors with polypropylene plate and metal nail, ISOVER PROFI FASSADE ANCHOR or ISOVER PROFI FASSADE ANCHOR PB, which will take on part of the loads resulting from the action of the wind. The number of anchors per m² varies, depending on the height and type of facade area, wind speed and degree of exposure of the building. For buildings with a height of less than 50 m, located in areas where the base value of the wind speed is less than 85 km/h, a number of 6 anchors / m² is sufficient for anchoring the thermal insulation slabs in the current field of the facade. Above this height the number of anchors will be determined based on calculations, equating these areas with the exposed areas at the corners of buildings. The layout schemes of the anchors can be with anchors in the middle of the slab or with anchors on the edges and in the middle of the slab. The holes for fixing the anchors will be made using the technique suitable for the type of wall, and the drill used will be chosen according to the diameter of the dowel and the length of the anchor. Anchors are fixed by tapping in the case of concrete, full or hollow brick walls and by screwing in the case of autoclaved aerated concrete walls. The plate should be buried 1-2 mm relative to the level of the heat-insulating slab or flush with the surface of the slab. Cover the head of the anchor with adhesive, and after it dries, remove the excess material, clean it from dust, so as to result a smooth surface.

Main assembly operations (2/3)

<p>Mounting of various profiles, reinforcement of the opening areas</p>	<p>Mounting the corner profile:</p> <ul style="list-style-type: none"> At the vertical corners of the wall, special profiles with reinforcing mesh will be mounted, ISOVER PROFI FASSADE CORNER. Apply a layer of base coat adhesive on both sides of the corner, on a width of 10 - 15 cm, after which the corner profile is mounted, by pressing and embedding in the base coat adhesive layer. Remove excess material and let it dry. <p>Mounting the connection profile with the jamb:</p> <ul style="list-style-type: none"> For a tight and durable connection between the jamb and the thermal insulation system, a special connection profile is used. Advantage - it avoids the appearance of thermal bridges through the hermetic connection between the jamb and the thermal insulation. <p>Mounting of the connection profile with the window frame:</p> <ul style="list-style-type: none"> Bond strips of thermal insulating material with a thickness of at least 3 cm in the side areas of the openings. For the flexible and tight connection between the window frame and the thermal insulation system (top, left and right, around the window), a connection profile with the window frame is used. Cut the profile to the desired size, partially remove the protection from the adhesive side and bond it to the surface of the window frame, by pressing and simultaneously removing the protection. The mesh part of the profile is embedded in the adhesive layer previously applied to the splits (side and top). <p>Mounting the corner profile in the window and door areas:</p> <ul style="list-style-type: none"> To protect the corner areas of windows and doors, the ISOVER PROFI FASSADE CORNER profile is mounted. Apply a layer of base coat adhesive on both sides of the corner, on a width of 10 - 15 cm, after which the corner profile is mounted, by pressing and embedding in the base coat adhesive layer. Remove excess material and let it dry. <p>Mounting the corner profile with dropper:</p> <ul style="list-style-type: none"> To ensure the outflow of water, thus protecting the wall, a corner profile with dropper is mounted. Apply a layer of base coat adhesive on both sides of the corner, on a width of 10-15 cm, then mount the corner profile with dropper by pressing and embedding in the base coat adhesive layer. Remove excess material and let it dry. <p>Reinforcement of the window frame area:</p> <ul style="list-style-type: none"> The adhesive is applied on the surface of the thermal insulation material from the window frame area, embedding mesh strips to ensure a continuous reinforcement together with the already mounted profiles (corner profile and window frame connection profile). <p>Additional reinforcement of the corner area at windows and doors:</p> <ul style="list-style-type: none"> In order to avoid the appearance of cracks in the area of the outer corners of the windows and doors, they are additionally reinforced, using ISOVER PROFI FASSADE MESH glass fibre mesh strips, approx. 40 x 30 cm. Apply a layer of base coat adhesive to the corner areas of the opening and embed the reinforcing mesh strip in the adhesive, at an angle of 45° to the horizontal, then remove the excess material and let it dry. <p>Reinforcement of expansion joint areas:</p> <ul style="list-style-type: none"> At the expansion joints of the building, special profiles with reinforcing mesh will be used and the installation instructions from the vertical corners will be followed. The space left between the socle profiles and between the edges of the thermal insulation boards must be 2-3 cm. The base coat is applied to the faces of the thermal insulating material and the expansion profile is embedded in the adhesive layer. Remove the excess material and let it dry.
<p>Applying the base coat and embedding the glass fibre reinforcement mesh</p>	<ul style="list-style-type: none"> Before applying the base coat on the surface of the stone wool slabs, any irregularities of flatness, traces of dust or other debris, impurities will be eliminated. Prepare the base coat adhesive, ISOVER PROFI FASSADE FIX, by mixing using an electric mixer, by adding it to clean water, approx. 5.2-5.8 liters per 25 kg dry mortar, leave to rest approx. 5 minutes, re-mix, after which it can be used. The surface of the stone wool slabs is primed with a thin layer of base coat adhesive, after which the material is spread in an even layer with an average thickness of 3 mm, with the help of a notched trowel with teeth sizes of 6x6 or 8x8 mm. Glass fibre reinforcing mesh ISOVER PROFI FASSADE MESH is spread in vertical direction and is embedded in the adhesive layer, by pressing it from the inside to the edges of the strip, being careful not to make wrinkles (folds). Two adjacent reinforcing mesh strips will overlap at least 10 cm. Apply the second layer of base coat, in a "wet on wet" system, in thickness of approx. 1.5 - 2 mm, leveling the surface so that the mesh is fully covered, and the total thickness of the reinforced mortar layer is at least 4-5 mm. The best mechanical strength of the reinforced layer of base coat is achieved when the mesh is in the upper third of its thickness.
<p>Applying the primer</p>	<ul style="list-style-type: none"> After proper drying of the base coat (5-7 days), remove all unevenness or traces left by the trowel and clean the prepared surface from dust. Before applying decorative render, in order to reduce and even out the water absorption of the support and improve adhesion, the ISOVER PROFI FASSADE PRIME primer is applied, and left to dry for 12-24 hours. The color of the primer is chosen depending on the color of the decorative render. Mix the contents of the bucket beforehand, after which the primer is applied with brush or paint roller over the entire surface to be rendered. Decorative render can be applied only after complete drying of the primed surface, which takes approx. 12 - 24 hours.

Main assembly operations (3/3)

Applying of decorative render	<ul style="list-style-type: none"> • ISOVER PROFI FASSADE DECOR decorative render will be applied at an air temperature and support temperature ranging from + 5°C to + 30°C . Do not apply during strong wind, rain or surfaces directly exposed to sunlight. The freshly applied render should be protected from sunlight, rain, frost or other weather effects, for 24-48 hours, until completely dry. • The application is started from top to bottom and is carried out without interruption on the surface of a facade, using the "wet on wet" method to avoid the appearance of joints and defects of structures. It can be interrupted at the boundaries between two shades of colors, at corners and other edges, vertical and horizontal joints. • The previously homogenized decorative render (mixing the contents of the bucket) is spread on the support with the help of a stainless steel trowel and leveled to the thickness of the largest grain in the material (1.5-2 mm depending on the grain), thus obtaining a thin and even layer. • The "agglomerated" structure type is obtained with a plastic trowel, by circular troweling, and the "scratched" structure type is obtained by linear or circular troweling of decorative render after approx. 5-15 minutes or immediately after application, depending on weather conditions (when the material no longer sticks to the plastic trowel). • The final structure can be influenced by the thickness of the layer and the way of troweling. In conditions of high humidity and low temperatures, the realization of the structure requires a test sample in advance.
--------------------------------------	---

ETICS system design and execution

The ETICS system will be executed on the basis of a technical project realised and verified by the authorized factors, according to the legislation in force.

The indications presented in this document are purely indicative, following, in part, examples according to the Guide on the design and execution of thermal rehabilitation works of residential buildings – indicative GP 123-2013.

Consequently, the present indicative information relates, in part, to certain types of buildings (blocks of flats), but is not limited to them. For the application of the system in different design conditions, technical projects will be drawn up according to the specific technical regulations (type of building, seismic risk and type of structure, other requirements etc.).

Determination of the required number of mechanical fixing anchors

The number of anchors per m² is influenced by:

- The characteristic pull-out force from the support
- Pull-through force through insulation
- Loads given by wind effect, the self-weight of the insulation
- Building height
- Location of the construction
- Geographical area
- etc.

Height of facade area	Facade area type	Number of anchors per m ² (indicative)
Up to 50 m high	current	6 anchors / m ²
	edge	Determination by calculation
Over 50 m height	any	

For edge (corner) areas, the number of fixing anchors shall be calculated for the pullout force ≥ 0.8 kN/anchor.

Tipo-size of the anchors

The length of the anchor (L_d) is determined taking into account the thickness of the thermal insulation material, the thickness of the adhesive layer, the thickness of the existing plaster (if applicable) and the minimum anchoring length.

$$L_d = A + g + a + d$$

The depth in the wall of the hole for the anchor (A_g) will exceed by approx. 10 mm the anchor length (A).

Wind speed values	Exposure, Terrain or Area	Number of anchors / m ² (indicative, accd. to GP 123-2013 Guide)		
		Building height		
		≤ 10 [m]	10 - 25 [m]	25 - 50 [m]
85 - 115 km/h	I , II , III	6	6	6
	I	8	8	10
	II	6	6	8
> 115 - 135 km/h	III	6	6	8
	I	10	12	12
	II	8	10	10
	III	6	8	10

Legend:

I - Open land, isolated object, wind power is not reduced by surrounding buildings

II - Wind power is slightly reduced by surrounding objects (scattered buildings and $H < 10$ m)

III - Wind power is strongly reduced by surrounding objects (urban agglomerations)

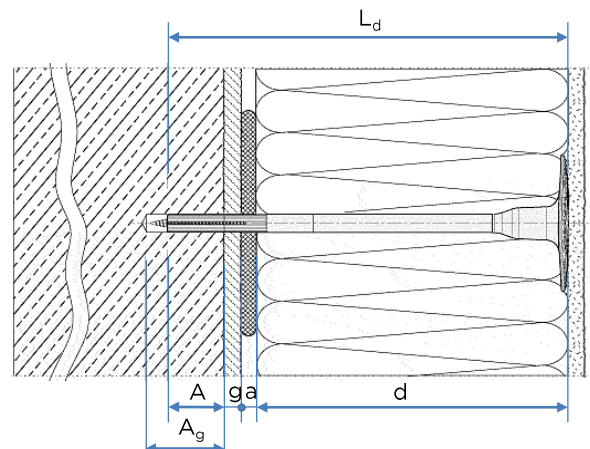

Attention:

For the appropriate design of the fixings and the appropriate execution, please consult the Technical Data Sheets and Declarations of Performance of the anchors ISOVER PROFI FASSADE ANCHOR or, respectively, ISOVER PROFI FASSADE ANCHOR PB, with the values of strength, embedment depths, type, condition and support size etc. - specific to each anchor typo-dimension.

- ISOVER PROFI FASSADE ANCHOR - $L_d = 140...300$ mm - for fixing in solid brickwork, ceramic blocks with vertical holes, lightweight concrete blocks, autoclaved aerated concrete (AAC) etc. - with minimum embedment depths of 60 mm.
- ISOVER PROFI FASSADE ANCHOR PB - $L_d = 135...295$ mm - for fixing in concrete, solid brickwork, ceramic blocks with vertical holes, lightweight concrete blocks, autoclaved aerated concrete (AAC) etc. - with minimum embedment depths of 25 mm, 45 mm or 65 mm, depending on the type of support.

Anchor details

In case of thermal insulation with stone wool (MW) slabs, the "W" fixing scheme (Fig. 1.) is recommended, with the anchors mounted on the slab surface, at a distance of approx. 10 cm from the edge.

The "T" fixing scheme (Fig. 2.) is usually used in the case of thermal insulation with expanded polystyrene (EPS), with the anchors mounted at the intersection points between the vertical and horizontal joints and one or more anchors in the middle of each board. For using this fixing scheme for anchoring the stone wool slabs, it is recommended that anchors with an additional flanche with the diameter of min. 140 mm be used.

Fig. 1.

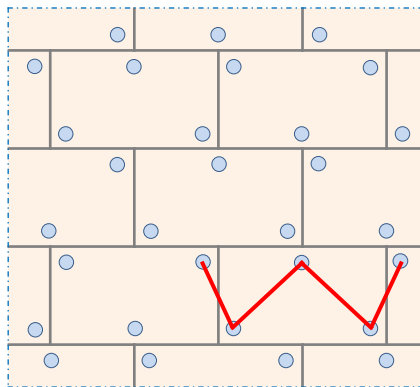
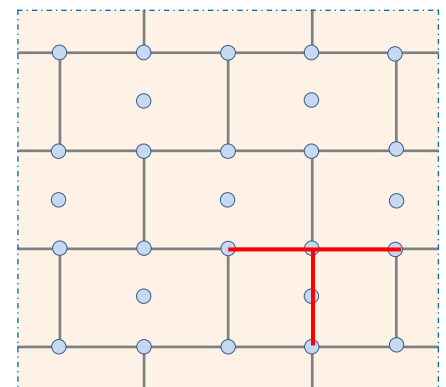
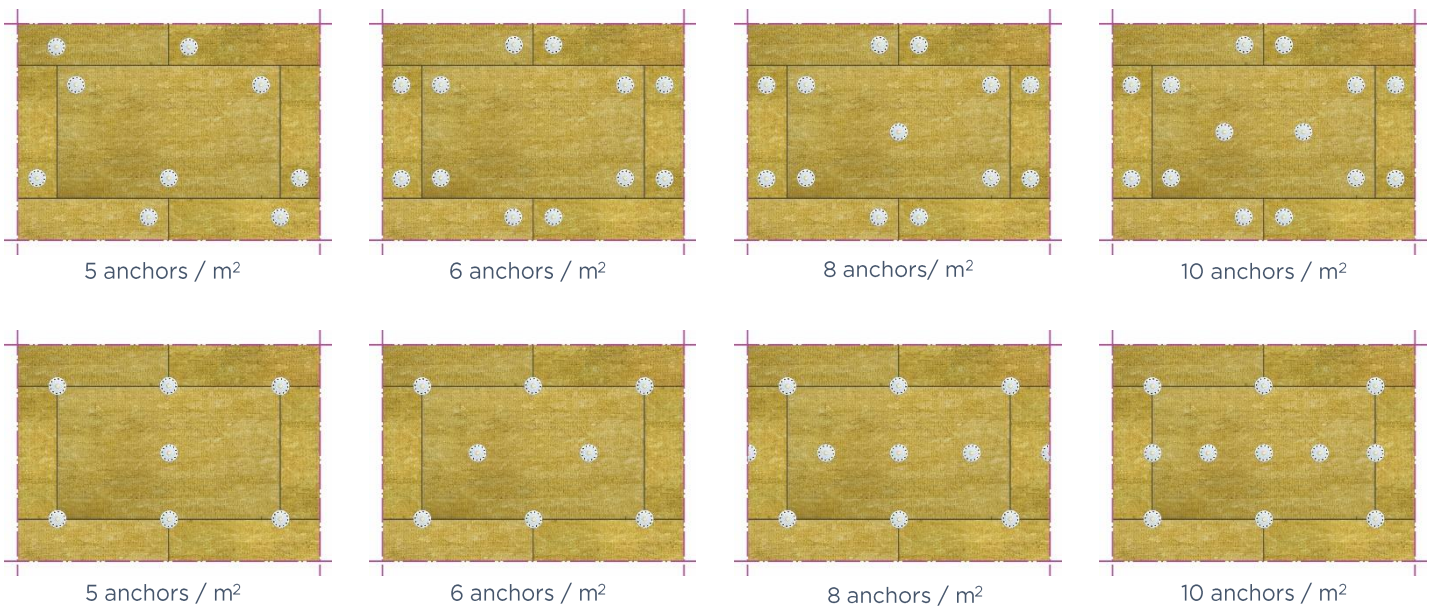

Fig. 2.



Layout schemes of anchors

Examples of anchor arrangement schemes:



The instructions for the execution of the system in this Technical Data Sheet represent the main aspects that need to be known for this product, which complete and/or customize the general rules of execution for ETICS type thermal insulation works (for more information access the QR code). The execution of the works is done exclusively according to the prescribed tasks and the details of the technical project, drawn up and verified according to the legislation in force.

Characteristics of the thermal insulating product - ISOVER PROFI FASSADE stone wool - accd. to SR EN 13162

Characteristic	Specification
Thermal conductivity	max. 0,036 W/mK
Short-term water absorption W_p	max. 1,0 kg/m ²
Long-term water absorption W_{lp}	max. 3,0 kg/m ²
Thickness - class	T5
Dimensional stability	DS(70,90)
Reaction to fire	cls. A1
Water vapour permeability of the thermal insulation product (water-vapour resistance factor μ):	MU1
Tensile test perpendicular to the faces of the thermal insulation product – in dry conditions:	min. 10 kPa
Compressive stress at 10 % deformation	30 kPa

Material consumption per m ²	Material	Unit cons.	unit
<p>Note: The consumption was calculated on a reference wall surface with the dimensions H x L = 4 m x 10 m.</p> <p>Does not include: - accessories (plinth profile, corner profile, profile with dropper etc.); - technological losses.</p>	ISOVER PROFI FASSADE FIX Adhesive for bonding stone wool slabs – medium layer thickness 10 mm	6	kg
	ISOVER FASSADE or ISOVER PROFI FASSADE Stone wool slabs	1	m ²
	ISOVER PROFI FASSADE ANCHOR or ISOVER PROFI FASSADE ANCHOR PB Anchors with polypropylene plate and metal nail	6*	pcs
	ISOVER PROFI FASSADE FIX Base coat adhesive for reinforcing stone wool slabs – medium layer thickness 4 mm	4	kg
	ISOVER PROFI FASSADE MESH Glass fibre mesh, with a minimum density of 160 g/m ²	1,1	m
	ISOVER PROFI FASSADE PRIME Primer for decorative renders	0,25 - 0,30	kg
	ISOVER PROFI FASSADE DECOR Decorative render, based on silicone dispersions (average layer thickness 1,5...2 mm)		
	• R955 – fine grain	2,4 - 3,1	kg
	• R855 – medium grain	3,3 - 3,8	kg
	• R655 – rolling grain	1,8 - 2,4	kg

* indicative value. The number of anchors will be chosen based on the technical project, following verifications and calculations.

The present average unit consumptions are indicative, advisory in nature. The documentation of the quotations for constructions and commercial orders will be made exclusively by the authorized factors of the project, the present information being only indicative, the quantities may differ per project.